

Quick Installation Guide of WLAN Broadband Router

※ To avoid users without access right through your WLAN Broadband Router, suggest that use security mechanism like WEP, WPA or set ID/password for web configuration login IP address 192.168.1.254.

Preparation

- 1 At least one PC with IEEE802.11b/g/n WLAN client installed.
- 2 One straight-through Category Ethernet cable, used to link WAN interface to xDSL or CM for Internet connection.
- 3 WLAN Broadband Router.

Check package contents:

- ✓ WLAN Broadband Router
- ✓ DC Power Adapter
- ✓ User's manual CD-ROM
- ✓ RJ-45 Cable Line (Option)

Collect Installation Information:

WAN configuration (Contact your ISP or network administrator for these information)

DHCP Client

Static IP

IP Address	<input type="text"/> . <input type="text"/> . <input type="text"/> . <input type="text"/>
Subnet Mask	<input type="text"/> . <input type="text"/> . <input type="text"/> . <input type="text"/>
Default Gateway	<input type="text"/> . <input type="text"/> . <input type="text"/> . <input type="text"/>
DNS Address	<input type="text"/> . <input type="text"/> . <input type="text"/> . <input type="text"/>

PPPoE

User Name	<input type="text"/>
Password	<input type="text"/>

PPTP

IP Address	<input type="text"/> . <input type="text"/> . <input type="text"/> . <input type="text"/>
Subnet Mask	<input type="text"/> . <input type="text"/> . <input type="text"/> . <input type="text"/>
Server IP Address	<input type="text"/> . <input type="text"/> . <input type="text"/> . <input type="text"/>
User Name	<input type="text"/>
Password	<input type="text"/>

Quick Installation Guide of WLAN Broadband Router

- **L2TP**

IP Address	<input type="text"/> . <input type="text"/> . <input type="text"/> . <input type="text"/>
Subnet Mask	<input type="text"/> . <input type="text"/> . <input type="text"/> . <input type="text"/>
Server IP Address	<input type="text"/> . <input type="text"/> . <input type="text"/> . <input type="text"/>
User Name	<input type="text"/>
Password	<input type="text"/>

LAN configuration

IP Address	<input type="text"/> . <input type="text"/> . <input type="text"/> . <input type="text"/>
Subnet Mask	<input type="text"/> . <input type="text"/> . <input type="text"/> . <input type="text"/>

WLAN configuration

SSID	<input type="text"/>
Mode	<input type="text"/>
Channel Number	<input type="text"/>

LED Panel Description

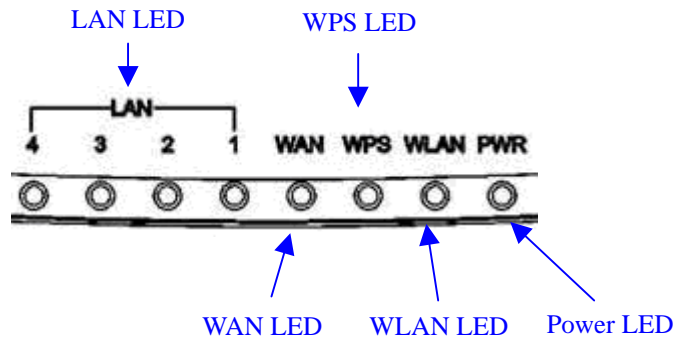

LED Indicator	State	Description
1. Power LED	On	The WLAN Broadband Router is powered on.
	Off	The WLAN Broadband Router is powered off.
2. WLAN LED	Flashing	WLAN is active
	Off	WLAN is off
3. WPS LED	Flashing	The WPS feature is Enabled.
	Off	The WPS feature is Disabled.
4. WAN LED ACT	Flashing	Data is transmitting or receiving on the WAN

Quick Installation Guide of WLAN Broadband Router

		interface
	On	Port linked.
	Off	No link.
5. LAN LED		
ACT	Flashing	Data is transmitting or receiving on the LAN interface.
	On	Port linked.
	Off	No link.

Back Panel Description

Type1

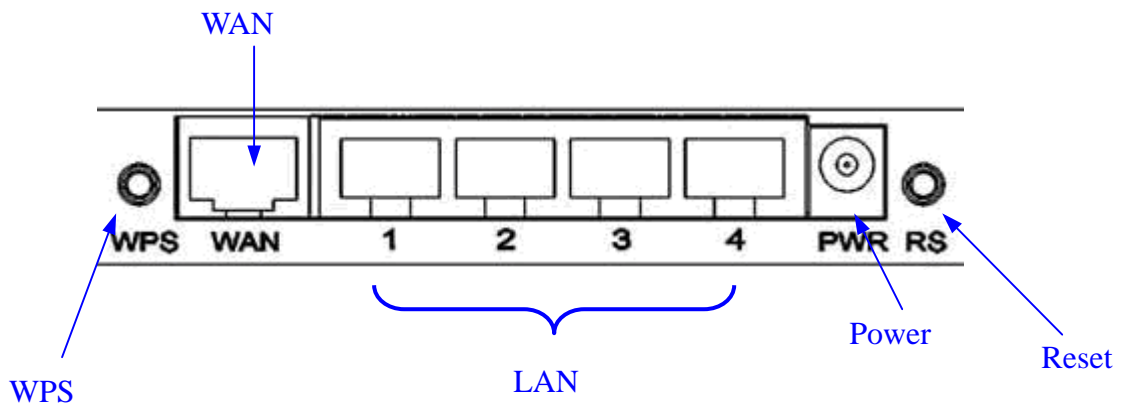

Type2

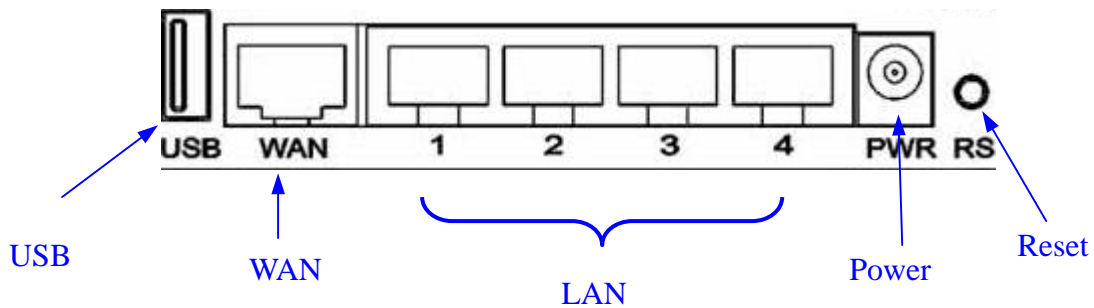

Quick Installation Guide of WLAN Broadband Router

Type3

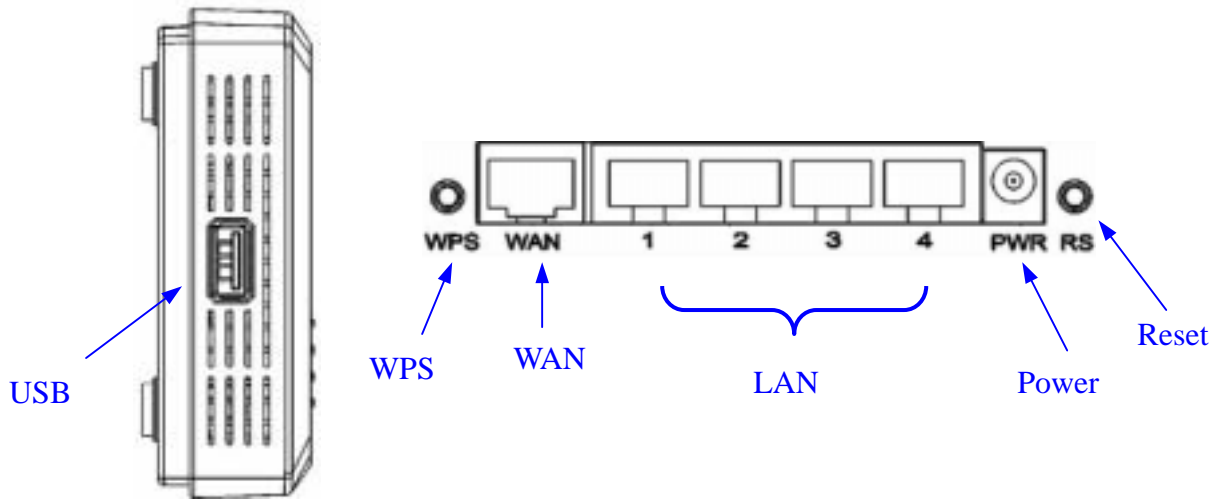

Interfaces	Description
Wireless Antenna	The Wireless LAN Antenna in box.
PWR (Power)	The power jack allows an external DC power supply connection. The external DC adaptor provide adaptive power requirement to the WLAN Broadband Router.
LAN	The RJ-45 sockets allow LAN connection through Category 5 cables. Support auto-sensing on 10/100M speed and half/ full duplex; comply with IEEE 802.3/ 802.3u respectively.
WAN	The RJ-45 socket allows WAN connection through a Category 2 cable. Support auto-sensing on 10/100M speed and half/ full duplex; comply with IEEE 802.3/ 802.3u respectively.
RS (Reset)	Push continually the reset button 5 ~ 10 seconds to reset the configuration parameters to factory defaults.
WPS	Push continually the reset button 5 ~ 10 seconds to enable the WPS feature.
USB	The USB port allows USB Storage connection to support FTP server、 File server.

Quick Installation Guide of WLAN Broadband Router

Installation

Step One – Power On WLAN Broadband Router

Connect DC Power Adapter to WLAN Broadband Router and the wall power socket.

Notice: It will take about 50 seconds to complete the boot up sequence after powered on the WLAN Broadband Router; Power LED will be active, and after that the WLAN Activity LED will be flashing to show the WLAN interface is enabled and working now.

Step Two – Configure WLAN Broadband Router

1. Connect your PC to LAN port for configuration setting. WLAN Broadband Router is delivered with the following factory default parameters on the Ethernet LAN interfaces.

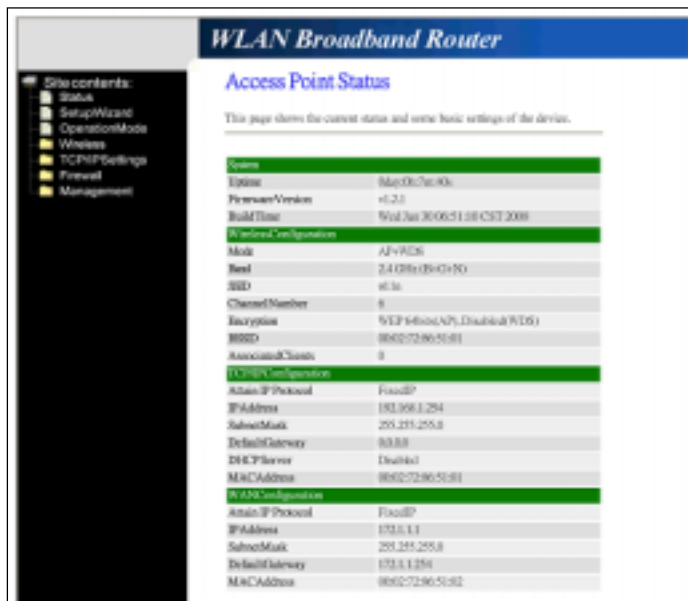

System	
Epilot	May 05, 2006
Firmware Version	v1.2.0
Build Date	Wed Jun 20 06:51:08 CST 2006

Access Point Configuration	
Mode	AP+PDS
Band	2.4 GHz (802.11G)
SSID	wl3n
Channel Number	6
Encryption	WEP 64bit(AES Disabled WDS)
BSSID	080072365581
Associated Clients	0

Ethernet Configuration	
Access IP Protocol	Fixed IP
IP Address	192.168.1.254
Subnet Mask	255.255.255.0
Default Gateway	0.0.0.0
DNS Servers	Disabled
MAC Address	080072365581

WLAN Configuration	
Access IP Protocol	Fixed IP
IP Address	173.3.1.1
Subnet Mask	255.255.255.0
Default Gateway	173.3.1.254
MAC Address	080072365582

- Default IP Address: **192.168.1.254**
- Default IP subnet mask: **255.255.255.0**
- WEB login User Name: *<empty>*
- WEB login Password: *<empty>*
- Configure your PC with IP address between 192.168.1.1 to 192.168.1.253 and subnet mask to be 255.255.255.0, then open an Internet browser (i.e. Microsoft IE6.1 SP1 or above) to connect WLAN Broadband Router by entering <http://192.168.1.254> to URL field.

The following example is to configure router as “Gateway” mode that use factory default value. You may change those values if you think that is necessary.

Quick Installation Guide of WLAN Broadband Router

2. Click “Setup Wizard” in submenu of Site contents

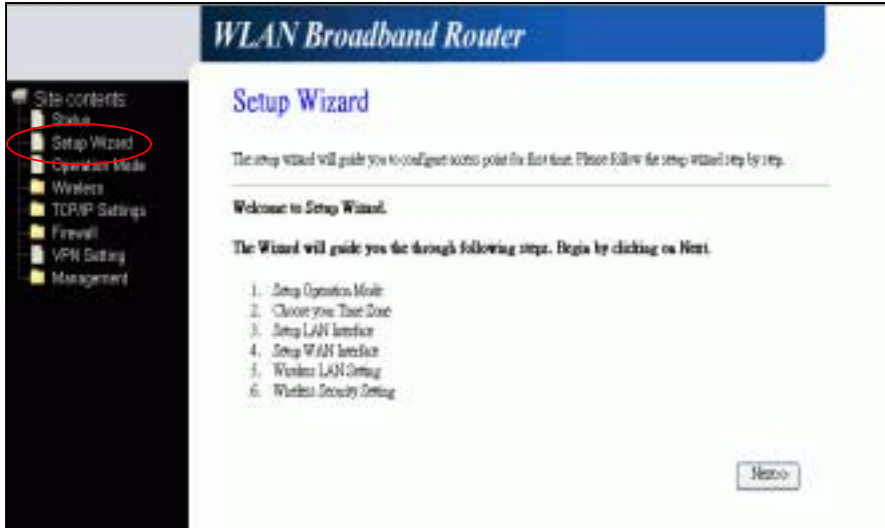

- Click “Next>>” button to go next.

3. Configure Operation Mode

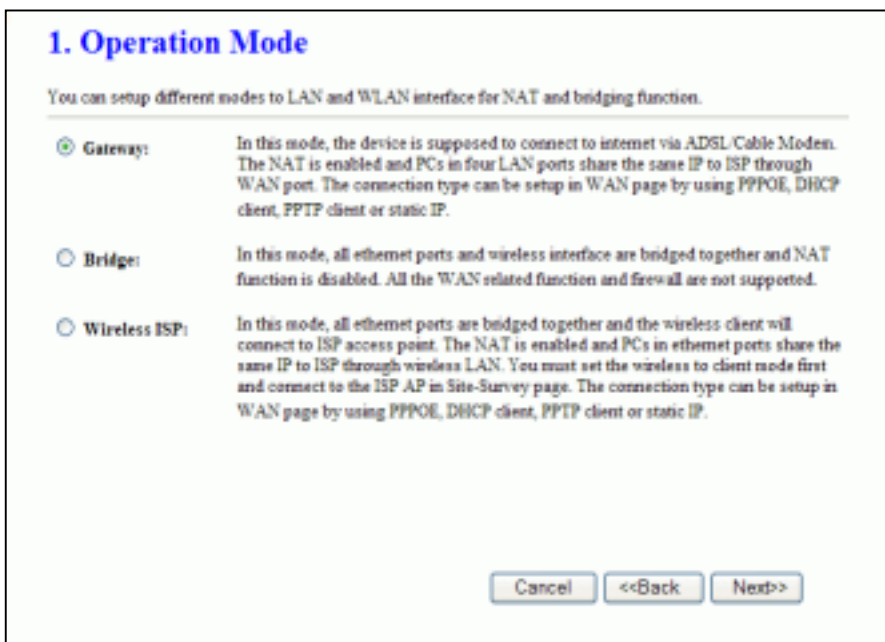

- Click “Gateway”.
- Click “Next>>” button to go next.

Quick Installation Guide of WLAN Broadband Router

4. Configure Time Zone Setting configuration

2. Time Zone Setting

You can maintain the system time by synchronizing with a public time server over the Internet.

Enable NTP client update

Automatically Adjust Daylight Saving

Time Zone Select : (GMT+08:00)Taipei

NTP server : 192.5.41.41 - North America

Cancel <<Back Next>>

- Click “Next>>” button to go next.

5. Configure LAN Interface Setup

3. LAN Interface Setup

This page is used to configure the parameters for local area network which connects to the LAN port of your Access Point. Here you may change the setting for IP address, subnet mask, DHCP, etc..

IP Address: 192.168.1.254

Subnet Mask: 255.255.255.0

Cancel <<Back Next>>

- IP Address:
192.168.1.254.
- Subnet Mask:
255.255.255.0.
- Click “Next>>” button to go next.

6. WAN Interface Setup

4. WAN Interface Setup

This page is used to configure the parameters for Internet network which connects to the WAN part of your Access Point. Here you may change the access method to static IP, DHCP, PPPoE or PPTP by click the item value of WAN Access type.

WAN Access Type: DHCP Client

Cancel <<Back Next>>

- WAN Access Type: Select WAN connection of ISP provides.
- ✧ WAN Options:
Static IP, DHCP Client, PPPoE, PPTP, L2TP
- Click “Next>>” button to go next.

Quick Installation Guide of WLAN Broadband Router

7. Wireless Basic Settings

5. Wireless Basic Settings

This page is used to configure the parameters for wireless LAN clients which may connect to your Access Point.

Band: 2.4 GHz (B+G+N)

Mode: AP

Network Type: Infrastructure

SSID: MyWLAN

Channel Width: 40MHz

ControlSideband: Upper

Channel Number: 11

Enable Mac Clone (Single Ethernet Client)

- Band: 2.4GHz(B+G)
- Mode: AP
- Network Type: disabled
- SSID: MyWLAN
- Channel: 11
- Enable Mac Clone: disabled
- Click “Next>>” button to go next.

8. Wireless Security Setup

6. Wireless Security Setup

This page allows you setup the wireless security. Turn on WEP or WPA by using Encryption Keys could prevent any unauthorized access to your wireless network.

Encryption: WEP

Key Length: 64-bit

Key Format: Hex (10 characters)

Key Setting: *****

- Encryption: None
- ◇ Options:
 - WEP, WPA (TKIP), WPA2 (AES), WPA2 Mixed
- Click “Finished” button to close setup session.

Quick Installation Guide of WLAN Broadband Router

Step Three – Connect WLAN client to WLAN Broadband Router wirelessly

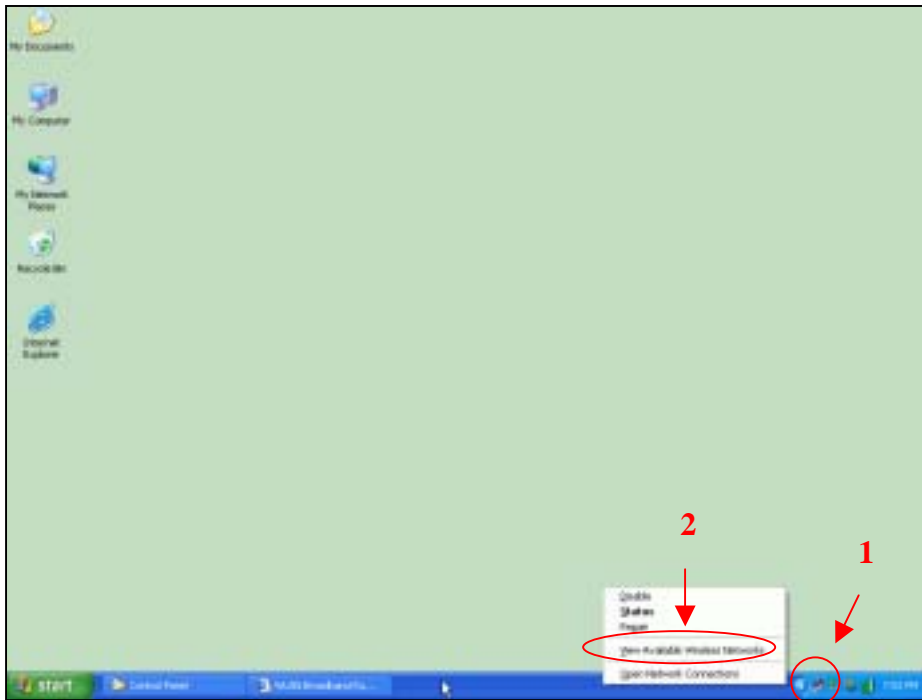

- On your wireless client PC:
1. Move your mouse to the Network icon on the Task bar and right click the mouse button to bring up the pop-up menu.
 2. Click the View Available Wireless Networks on the pop-up menu.

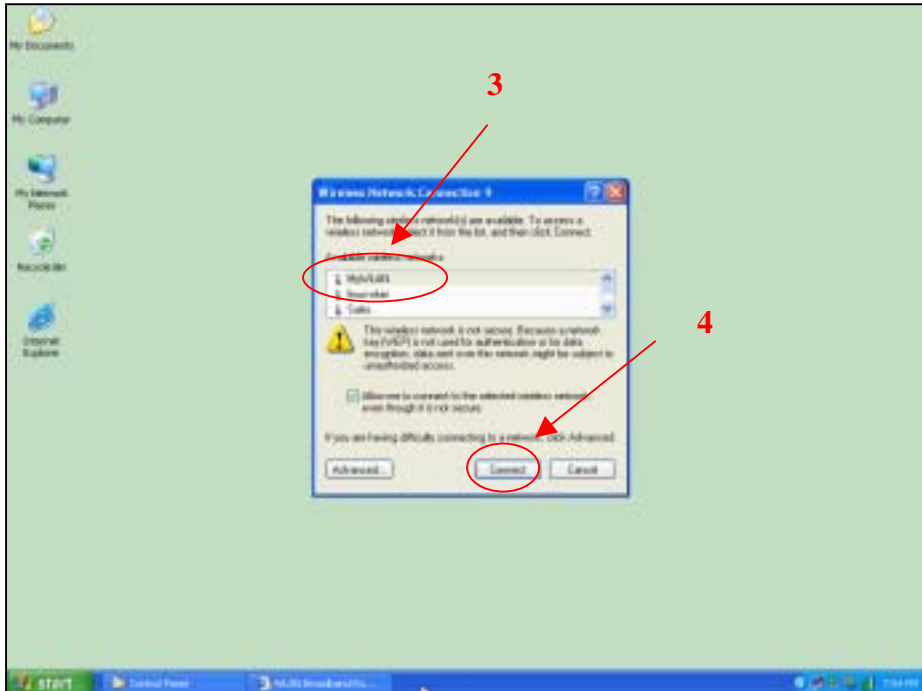

3. Select the specific WLAN network (SSID) from the Available Networks list.
4. Click the Connect button to establish the communication link to the wireless network

Quick Installation Guide of WLAN Broadband Router

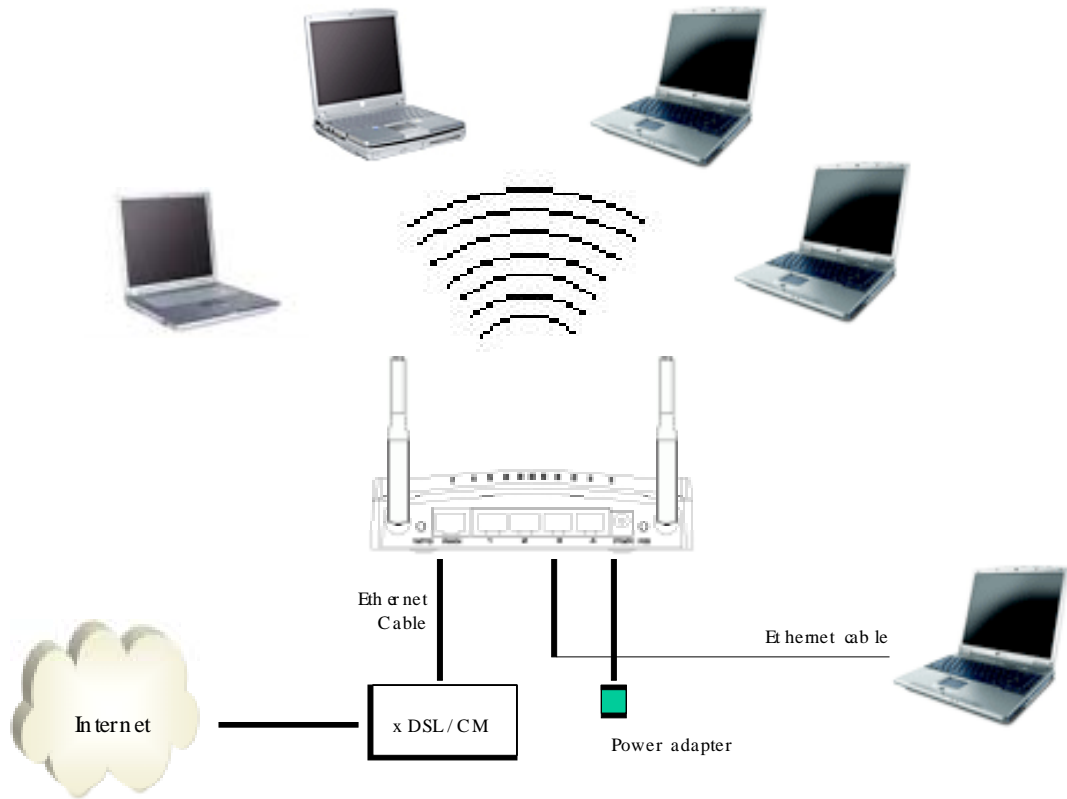

The wireless network diagram of WLAN Broadband Router..

Reference

Please consult the user's manual of WLAN Broadband Router for detailed and complete operation guide.